



Boulder 1012 DAC Preamplifier

Owners Manual

10/27/03

Boulder Amplifiers, Inc.
3235 Prairie Ave.
Boulder, CO 80301
www.boulderamp.com

APPENDIX

RECORDING

BOULDER
LINK

PROGRAMMING

REMOTE
CONTROL

OPERATION

GETTING
STARTED



Boulder 1012 DAC Preamplifier Rear Panel

TABLE OF CONTENTS

GETTING STARTED

Introduction	1-1
Quick Start	1-1
Placement of the 1012 DAC Preamplifier	1-2
Connecting to the Mains Outlet	1-3
Connecting a Digital Source.....	1-4
Polarity	1-5
Connecting a Balanced Analog Source.....	1-5
Connecting an Unbalanced Analog Source.....	1-6
Connecting a Turntable.....	1-7
Connecting to a Balanced Input Amplifier	1-9
Connecting to an Unbalanced Input Amplifier	1-10
Setting the Boulderlink Switch	1-11

OPERATION

Powering Up.....	2-1
Input Selections	2-2
Volume.....	2-4
Balance.....	2-5
Mute.....	2-6
Display.....	2-7

APPENDIX

RECORDING

BOULDER
LINK

PROGRAMMING

REMOTE
CONTROL

OPERATION

GETTING
STARTED

REMOTE CONTROL

Batteries 3-1
Source Selection 3-2
Volume, Balance and Mute. 3-2
Polarity 3-3

PROGRAMMING

Input Names 4-1
Input Polarity 4-2
Theater Mode 4-3
Input Level Calibration. 4-3
Input Balance Calibration. 4-4
Main Outputs Polarity 4-5
Boulderlink ID 4-6
Remote ID 4-6
Master Reset 4-7

BOULDERLINK

Connecting the Boulderlink 5-1
Setting Boulderlink Switches 5-2
Setting Boulderlink ID Numbers. 5-2
Power up via Boulderlink 5-3
Boulderlink Messages 5-4

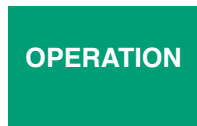
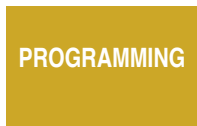
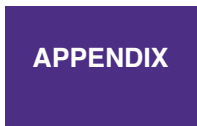

RECORDING

Connecting a Recording Device 6-1

APPENDIX

Block Diagram 7-1
Specifications 7-2
Troubleshooting 7-4
Notes 7-5

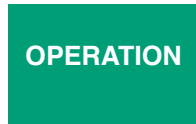
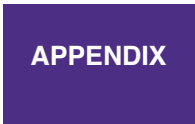

GETTING STARTED

INTRODUCTION

Congratulations on your selection of the Boulder 1012 DAC Preamplifier. We at Boulder Amplifiers are certain it will provide years of listening pleasure.

QUICK START

To get started listening, you only need to connect the 1012 as you would any other preamplifier, but you should take note of the following.

WARNING: The polished volume control is attractive and because it is optical and has no stops, it is really tempting to just spin it around. **DO THIS ONLY WITH THE POWER OFF!** It must be given the respect you would any other volume control with its ability to get loud very quickly. By the time you have turned it up to -40.0 dB with a source turned on, you should be hearing some music. If not, don't proceed any louder until you have solved the problem. See trouble shooting section.

For the 1012 to work properly, the Boulderlink's MASTER/SLAVE switch should be set to MASTER.

A thorough reading of this manual will definitely enhance your enjoyment of your 1012 DAC Preamplifier.



PLACEMENT OF THE 1012 DAC PREAMPLIFIER

Your Boulder 1012 DAC Preamplifier is designed to reduce the effects that external magnetic and radio fields (RF) have on its internal circuitry. While placement is not critical, known magnetic fields should be avoided. Line of sight from the listening position is necessary for the remote control to function properly.

Because the preamplifier is heavy, a solid, stable surface should be used. As it will generate some heat, there should be good air circulation around it. In particular, make certain that the power supply heat sink fins on the rear of the chassis are not blocked.

You may want to have some access to the rear panels for cable changes.



CONNECTING TO THE MAINS OUTLET

Your 1012 DAC Preamplifier is supplied with a mains cord suitable to the location where it was purchased.

A label showing the exact voltage and frequency range is located on the rear panel. Make certain that the mains voltage used is within the specifications shown. Also listed are the fuse ratings. There are two fuse holders on the rear of the 1012 which are for each of the digital and analog power transformers.

Use only specified fuses. Check with qualified service person first.

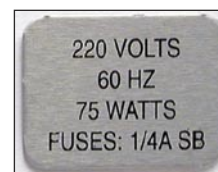
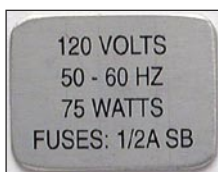

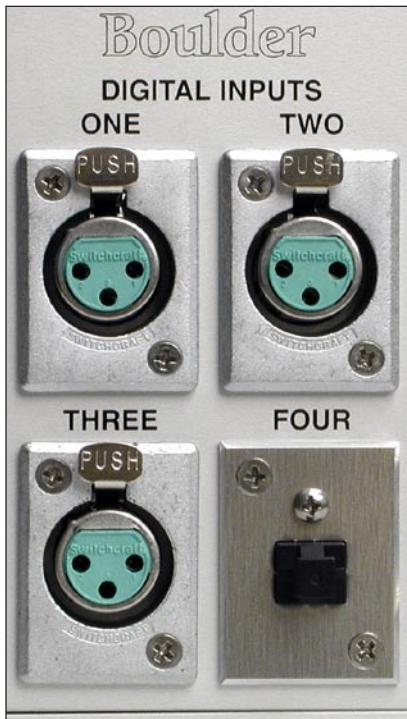

CONNECTING A DIGITAL SOURCE

There are four digital inputs to the DSP and D/A Converter section of the 1012. Three inputs are the AES/EBU style. Because of the balanced nature of these connections, it is the preferred method of connection and should be used whenever available.

With the 1012, one DABL digital adapter is supplied and may be plugged into any one of these inputs thus converting it to RCA phono style SPDIF. Additional adapters are available if more than one input needs conversion.

WARNING: In order to maintain proper impedance and level matching, it is important to always use the DABL adapter when coming from an unbalanced RCA phono style digital source. Do not use a Boulder ABL analog adapter for this purpose.

The fourth connector normally supplied is toslink optical.

For possible future connections, consult your Boulder dealer.



POLARITY

Please note that the 1012 DAC Preamplifier conforms to the standard of pin 2 as the high or hot pin for all analog balanced inputs and outputs. Because input and output polarities are handled through programming setups and the remote control, no concern for polarity is needed while connecting sources.

Digital connectors have no polarity.

CONNECTING A BALANCED ANALOG SOURCE

To fully realize the sonic potential of your 1012 DAC Preamplifier, use balanced connections whenever possible. Balanced cables reduce interference from magnetic and RF sources to an absolute minimum.

Connect each line source to one of the three inputs provided. Later, you will be able to name each input with the source's name, so you might want to make a list as you connect them.

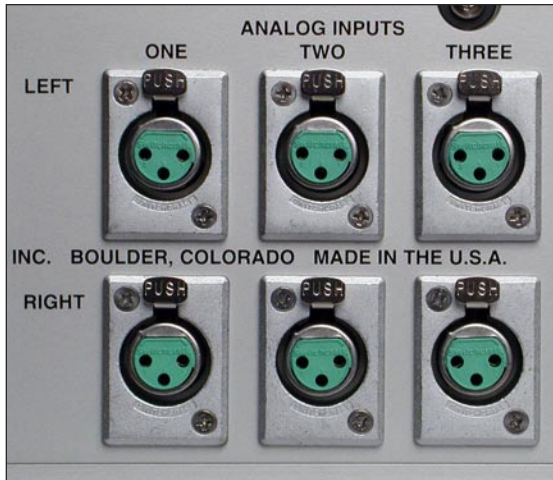

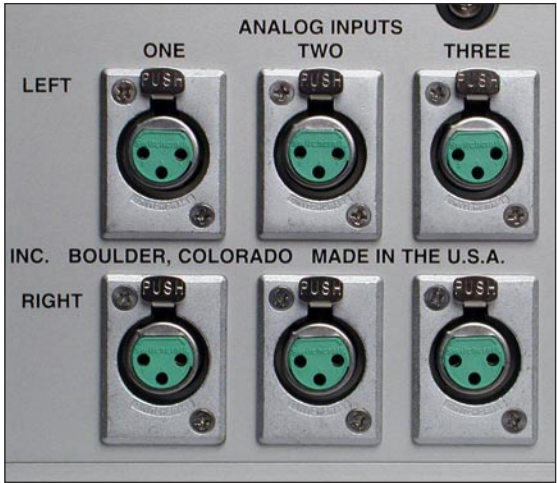

CONNECTING AN UNBALANCED ANALOG SOURCE

Although the inputs are all of the 3 pin type, an unbalanced source is easily accommodated by using a special cable. This cable has an RCA phono type connector on the source end and a 3 pin connector for going to an input on the 1012 DAC Preamplifier.

The minus input (pin 3) should be wired to ground only at the RCA phono connector. This brings the minus input reference of the 1012 to the unbalanced source ground, thus reducing ground loops.

Another option for accommodating unbalanced sources is that of the Boulder ABL analog input adapter. It converts a balanced input into a RCA phono input right at the rear of the 1012.

Like the above cable, the minus input of the 1012 is connected to the ground of the RCA phono. However, this minus side will then share the shield wire with the chassis ground and will not have the best hum rejection.

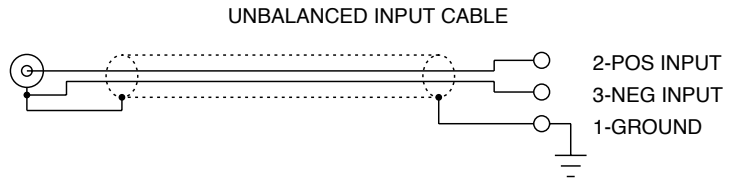



CONNECTING A TURNTABLE

Balanced inputs are provided for connecting a turntable to the 1012. To avoid hum pickup in the cabling, it is important to follow these instructions.

Do not connect pin 1 (chassis/ground) to either pin 2 or 3 at any point in the cable, turntable chassis, or tonearm. Pins 2 and 3 must only connect directly to the cartridge pins. This can be accomplished by several wiring schemes shown on the next page.

Do not use the Boulder ABL input adapter or other RCA Phono to XLR adapter.

Use either a connection from pin 1 to the turntable chassis or wire from the CHASSIS screw terminal to the turntable chassis, but do not use both.

For high level, moving magnet (MM) type cartridges, set the LEVEL switch to HIGH. For low level, moving coil (MC) type cartridges, set the LEVEL switch to LOW.

If in doubt, consult your Boulder dealer.

PHONO CABLES

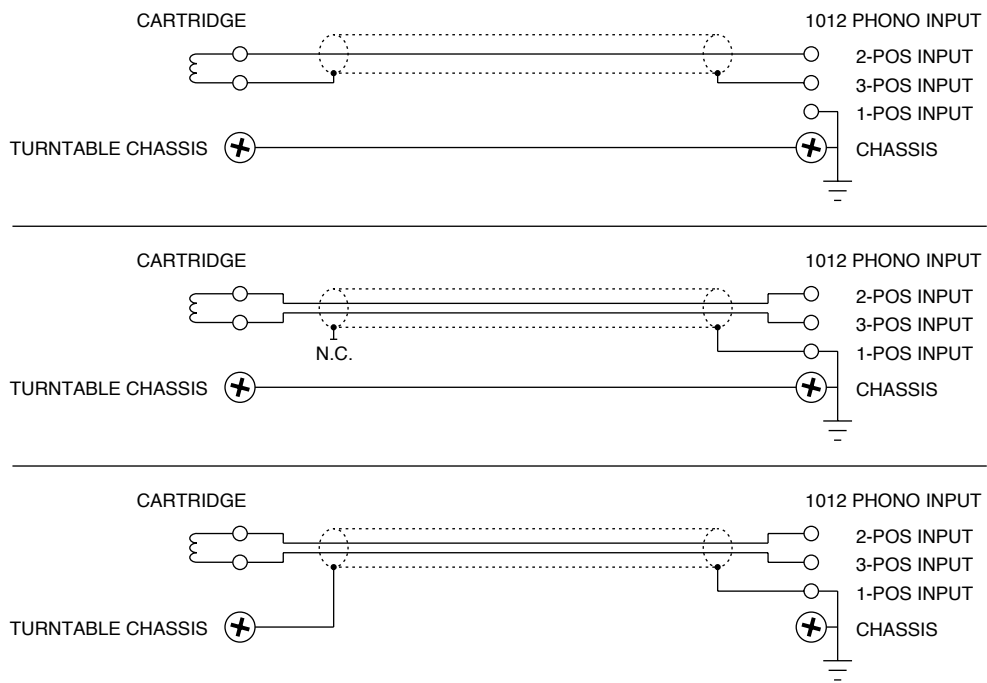



CONNECTING TO A BALANCED INPUT AMPLIFIER

With your 1012 DAC Preamplifier's balanced output driving a balanced input power amplifier, you can take sonic advantage of short speaker cables and correspondingly longer input cables. With the 1012's low output impedance, distances of more than 50 meters between preamplifier and power amplifier are practical.

Connect each amplifier input to the main outputs labeled "MAIN OUT." If it is desired to use 2 or more amplifiers such as in bi-amping, splitters will be required. If in doubt, consult your Boulder dealer.



CONNECTING TO AN UNBALANCED INPUT AMPLIFIER

A special cable is required to make this connection. This cable connects pin 1 to the shield and pin 2 to the center pin. It leaves the output pin 3 unconnected.

Connecting the unused output pin (usually pin 3) to ground will cause excessive ground currents and degrade performance. Use an ohmmeter or continuity checker to determine how a cable is wired.

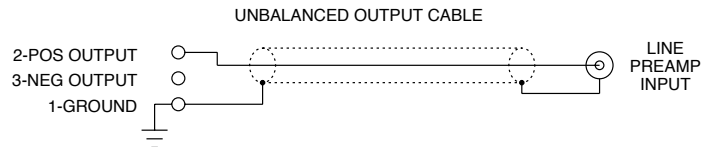



SETTING THE BOULDERLINK SWITCH

Set the Boulderlink MASTER / SLAVE switch to MASTER.

For more information on Boulderlink, see the Boulderlink section as indicated by the finger tabs below.



OPERATION

POWERING UP

With all your connections made, you are ready to listen to your Boulder 1012 DAC Preamplifier.

The power LED will cycle through a variety of colors indicating a standby mode. Power is applied only to the microprocessor during this mode.

Press the POWER button to turn on the 1012. The indicator will change to amber and power will be applied to the analog audio section. If a digital input was previously selected, power will also be applied to the DSP, D/A Converter, and analog low-pass filter sections which are used only for digital signals.

During the power up sequence, the displays at left will be briefly shown.

The front panel POWER button should be used for everyday turn on and off. This switch mutes the audio, turns off all sections except the microprocessor, and puts the preamplifier in a standby mode.

A rectangular LCD display with a black background and green text. The text is arranged in two lines: "Boulder 1012 DAC/PRE" on the top line and "DSP 24/192kHz READY" on the bottom line.

Boulder 1012 DAC/PRE
DSP 24/192kHz READY

A rectangular LCD display with a black background and green text. The text is arranged in two lines: "Boulder 1012 DAC/PRE" on the top line and "WAITING FOR AMPS 0" on the bottom line.

Boulder 1012 DAC/PRE
WAITING FOR AMPS 0

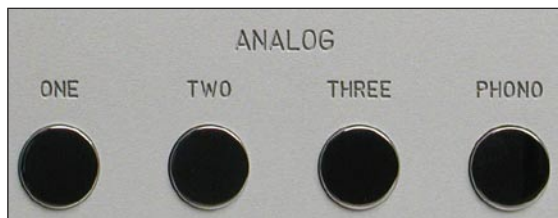

INPUT SELECTIONS

To select an analog input, press one of the ANALOG pushbuttons labeled ONE, TWO, THREE or PHONO. The respective input will be shown in the display and that signal will be routed to both the main and record outputs. For example, if input ONE is chosen, "A1. ANALOG INPUT 1" will show in the display.

NOTE: There will be a 1 second delay when switching from one source to another. This is necessary to allow the circuitry to adjust to the new input source.

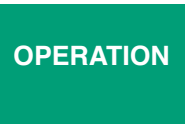



To select a digital input, press one of the DIGITAL pushbuttons labeled ONE through FOUR. For a few seconds, the input sample rate of the source and the Upandoversampling™ rate out of the DSP will be shown. For example, a regular CD will show “INPUT RATE 44.1kHz, OUTPUT RATE 705.6kHz.”

The “INPUT RATE” is the rate at which the 1012 receives data from the source. The “OUTPUT RATE” is the rate at which the 1012’s Digital Signal Processor (DSP) sends data to the converters. The ratio of these two numbers is the amount of Upandoversampling™ performed by the DSP.

Then the respective input will be shown in the display and that signal will be routed to both the main and record outputs. For example, if input ONE is chosen, “D1. DIGITAL INPUT 1” will show in the display.

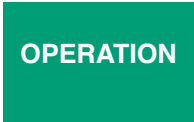



VOLUME

Because the precise feel of the Boulder 1012's volume control may be different than you are used to, we recommend starting the source device so that an audio signal is fed to the 1012 before increasing the volume.

The display will show "VOLUME INFINITE" to indicate maximum attenuation or no sound. By placing a finger at the edge of the rotating control and moving it slowly so it turns in a clockwise direction, the volume will increase and an indication such as "VOLUME - 40.0dB" in the display will show the respective volume.

At this point you should be listening to music. Each volume step is a change of 0.5 dB.

WARNING: The volume control must be given the respect you would any other volume control with its ability to get loud very quickly.

WARNING: If the input is programmed to be in "THEATER MODE," then the volume control will have no effect.

For more information, see THEATER MODE in the programming section.

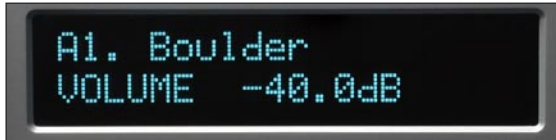



BALANCE

To change the level balance, press the BALANCE pushbutton. "BALANCE CENTERED" will show in the display. Now, rotating the control will change the balance instead of the volume for as long as "BALANCE..." is displayed.

Turning the control counterclockwise (left) will cause an indication such as "BALANCE R -2.0dB <" in the display. This means that the right channel has been attenuated -2.0 dB below the left channel, regardless of volume setting, making the left channel louder.

The range of balance offset is limited to -20.0 dB. If the control is then rotated further counterclockwise, the "BALANCE RIGHT MUTED<" will be displayed to indicate that only the left channel is on.

After several seconds of not changing the balance, the display will return to the "VOLUME..." indication. You may also return to controlling volume by again pressing the BALANCE pushbutton. The balance resolution is the same as for the volume control, 0.5 dB steps.

WARNING: If the input is programmed to be in "THEATER MODE," then the balance control will have no effect.

For more information, see THEATER MODE in the programming section.

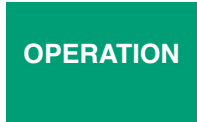

MUTE

To temporarily reduce the volume, press the MUTE pushbutton. "VOLUME MUTED" will show in the display, replacing the volume indication. Again pressing the MUTE pushbutton will return the volume to normal level.

While muted, the level of both channels will be reduced by -100 dB, regardless of volume setting.





DISPLAY

The display brightness may be set to any of 4 brightness levels.

To change the brightness level, press the DISPLAY pushbutton. "DISPLAY 100%" will show in the display. Rotate the control until the desired brightness is obtained such as "DISPLAY 50%." The number in the display is the relative brightness.

After several seconds of not changing the brightness level, the display will return to the "VOLUME..." indication. You may also return to controlling volume by again pressing the DISPLAY pushbutton.

With the display at a brightness less than that of 100%, any operation of a pushbutton or the volume control will cause the display to go to full brightness for several seconds, and then return to the desired brightness. This ensures that if a function is changed, it will be noticed whether intentional or inadvertent.

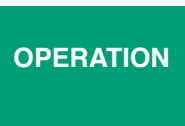



REMOTE CONTROL

BATTERIES

A standard small flat blade screwdriver is required to install the three AAA batteries. To install batteries in the remote control, it is necessary to separate the two sections.

WARNING: When opened, the pushbutton balls will be loose and care must be taken to properly retain them.

It is recommended to lay the remote control face down on a flat surface so that the balls will stay in position. Then, remove the three screws. Lift off the cover and set aside, making certain that the battery holder comes out from the cover. Install the batteries with the positive (+) terminals facing as indicated on the holder and replace the cover.

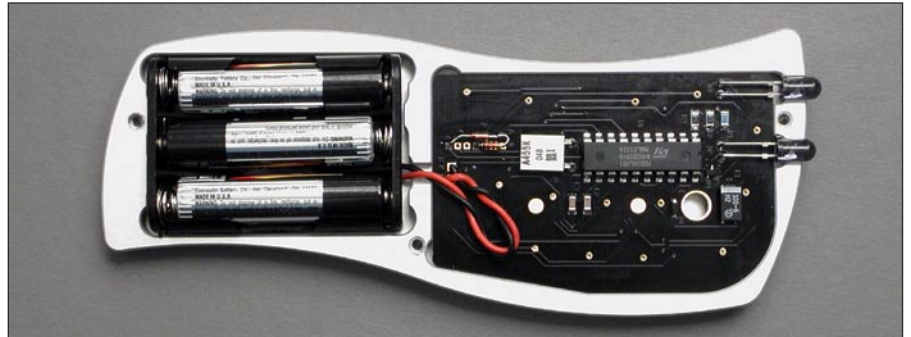

REMOTE
CONTROL



SOURCE SELECTION

To select an input (source) press one of the eight buttons on the left side of the remote control in the ANALOG and DIGITAL groups. You will now be listening to your desired source, and it will be showing in the display.

VOLUME, BALANCE and MUTE

To increase the volume, press the button marked with an up arrow. To reduce, press the one marked with a down arrow. Holding either button down will cause the volume to change continuously until released.

To change the balance to the left, press the button marked with a left arrow until the display shows "BALANCE CENTERED" and continue holding until the display shows the desired balance change. Similarly, you may change the balance to the right by holding the button marked with a right arrow.

To temporarily mute the audio, press MUTE. To return to normal audio level, again press MUTE.

POLARITY

NOTE: Often polarity is mistakenly called phase. As phase indicates any angle between two channels from 0 to 360 degrees, the correct term of polarity is preferred to indicate the 180° phase change, or inversion, available in the 1012 DAC Preamplifier.



By using the remote control, the polarity of both channels may be changed simultaneously at the main outputs during any listening mode. The record outputs are never affected by the polarity setting.

To change polarity, press the POL pushbutton on the remote control. "POLARITY INVERTED" will show in the display. Also, the decimal point after the source abbreviation (e.g. D1) will change to a "-" symbol for as long as the polarity remains inverted, even if the source is changed.



To return to normal (noninverted) polarity, again press the POL pushbutton. "POLARITY NORMAL" will show in the display.

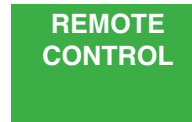

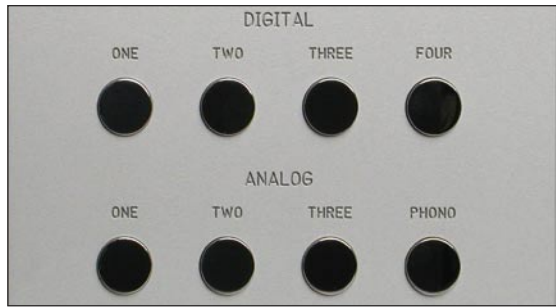

PROGRAMMING

While it is not necessary to ever use any programming functions, you will find they maximize the enjoyment of your Boulder 1012 DAC Preamplifier.

Each input has several programmable features associated with it. These include assigning an alphanumeric name of your choosing, setting an individual offset attenuation and balance, correcting polarity, and setting theater mode.

After holding down an input button until “RELEASE BUTTON NOW” is displayed, each additional press of this input button will step through the programming options. Changes made during the programming process are automatically stored as they are made. If no changes are made, the original settings are retained.

INPUT NAMES

For the analog inputs, press and hold the input number you wish to program. If you selected ONE, then “PROG ANALOG INPUT 1” will show in the top display row and “CHANGE NAME? NO” will show in the bottom display row. Rotating the volume control clockwise will allow you to choose “YES” if you want to change the name. Again press the same input source number to continue.

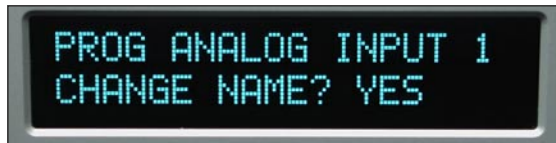
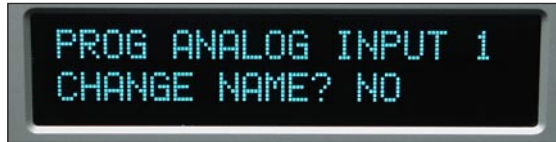



If you chose to assign a name, then “A1 ANALOG INPUT 1” will be shown in the bottom display row with a blinking cursor before the name’s first character. Rotate the control until the desired character appears. Press the same input source number to accept the displayed character and go to the next character. Continue in this manner until all 17 characters are set. For example, “Boulder” can be set.

NOTE: The space character is just before the exclamation mark (!).

INPUT POLARITY

Input polarity is used to match the 1012’s input polarity to that of each individual source. If uncertain of a particular source’s polarity, check the source’s owners manual or consult with its manufacturer.

After the last character is assigned, pressing the same input source number will make “INPUT PIN 2 POSITIVE” show in the bottom display row. As you rotate the volume control to “INPUT PIN 3 POSITIVE” the polarity relays will immediately activate. After the desired polarity is selected, or if no change is desired, press the same input source number.





PROG ANALOG INPUT 1
NORMAL MODE



PROG ANALOG INPUT 1
THEATER MODE-Caution

THEATER MODE

When the 1012 preamplifier is used in a surround sound theater system, it is normally desired to bypass the volume control, thus letting the surround processor control the volume.

WARNING: Setting an input to THEATER MODE forces the volume to unity gain. Use only in conjunction with a surround processor.

Again pressing the same input source number will make "NORMAL MODE" show in the bottom display row. Rotating the volume control will show "THEATER MODE-Caution."



PROG ANALOG INPUT 1
INPUT LEVEL 0.0dB



PROG ANALOG INPUT 1
INPUT LEVEL -6.0dB



PROG ANALOG INPUT 1
INPUT LEVEL -24.0dB

INPUT LEVEL CALIBRATION

Pressing the same input source number will make “INPUT LEVEL 0.0dB” show in the bottom display row. Rotating the volume control will change the display and the main outputs’ levels simultaneously. This allows calibration of each input with test tones if desired.

For example, setting the display to “-6.0dB” will allow an input which is twice the voltage of the other inputs to be heard at the same level. A maximum of -24 dB may be set.

This is easiest to do if you start with the quietest source as your reference, and then adjust the louder sources to match it.



PROG ANALOG INPUT 1
INPUT BAL CENTERED



PROG ANALOG INPUT 1
INPUT BAL R -9.0dB



PROG ANALOG INPUT 1
INPUT BAL R -12.0dB

INPUT BALANCE CALIBRATION

Pressing the same input source number will make “INPUT BAL CENTERED” show in the bottom display row. Rotating the volume control will simultaneously change the display and the main output’s balance so that the action can be monitored or measured.

For example, setting the display to “R -9.0dB” will make the left channel louder than the right channel. A maximum of -12 dB may be set.

Again pressing the same input source number will end the programming of this input and initiate a power up sequence.



PROGRAMMING BY THE DISPLAY BUTTON

Several special features are programmed by pressing and holding the DISPLAY pushbutton until the display changes indicating you are in a programming mode. If no action is taken for some time, then the 1012 reverts back to normal operation. The sequence is as follows.

MAIN OUTPUTS POLARITY

The polarity of the main outputs may be adjusted to match the power amplifiers used. For Boulder series 1000 or 2000 amplifiers, it should be set to "PIN 2 POSITIVE." If you are using a Boulder 100, 250 or 500 series, this should be set to "PIN 3 POSITIVE." For other brands, consult the product's owners manual. If uncertain, set to "PIN 2 POSITIVE."

Press and hold the DISPLAY pushbutton. "OUTPUT POLARITY, PIN 2 POSITIVE" will show in the display. Rotate the volume control until the desired polarity is shown in the display. The polarity changes simultaneously with the display.

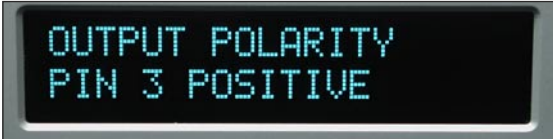



PROGRAM BOULDER LINK
BOUDLER LINK ID 20

BOULDERLINK ID

Again pressing the DISPLAY pushbutton will make "PROGRAM BOULDER LINK, BOULDER LINK ID 20" show in the display. Rotating the volume control changes the ID number. For more information consult the Boulderlink section.

Unless you are using two or more 1012 DAC Preamplifiers together, this setting should be left at "20."



PROGRAM REMOTE ID
REMOTE CONTROL ID 3

REMOTE ID

Again pressing the DISPLAY pushbutton will make "PROGRAM REMOTE ID, REMOTE CONTROL ID 3" show in the display. Rotating the volume control changes the ID number. This feature is used in conjunction with a wiring change in the remote control and should be left set at "3." Consult your dealer to change this setting.

BOULDERLINK SPEED

Again pressing the DISPLAY pushbutton will make "BOULDER LINK SPEED, 62500 BAUD-Standard" show in the display. Rotating the volume control changes the baud rate. This feature increases the 1012's compatibility with other brands of equipment. Consult your dealer to change this setting.



RESET TO FACTORY DEFAULTS

Should you wish to have all settings reset to original factory defaults, you may execute a master reset. Normally, this function is not used.

Press and hold the POWER pushbutton. "RESET ALL PARAMETERS, DIG 1=YES DIG 2=NO" will show in the display.

To leave all settings as they currently are, press the DIGITAL TWO pushbutton.

To reset all settings, press the DIGITAL ONE pushbutton.

WARNING: All settings which you have programmed in will be lost, including the names of each input.

The microprocessor and PROM version numbers are momentarily displayed.

All other pushbuttons are inoperative during this time. The 1012 DAC Preamplifier will then return to normal operating mode and initiate a power up sequence.



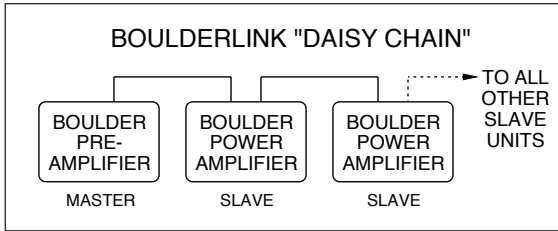

BOULDERLINK

Boulderlink is a means of interconnecting most Boulder products so that their microprocessors can talk to each other and pass important information. Among the key features, Boulderlink allows sequential initiation of power amplifiers' and other products' power up when the 1012 DAC Preamp is turned on. Power amplifiers can send messages to the 1012 which are then shown on its display.

CONNECTING THE BOULDERLINK

Turn off all products to be linked before connecting Boulderlink cables and setting Boulderlink ID and Master/Slave switches.

Boulderlink cables in various lengths are available as an accessory from your Boulder dealer. Two connectors are provided on the back of the 1012 and other Boulderlink enabled products.

All the chassis are connected together in a daisy chain manner. Start by connecting one chassis to another—then from that chassis to the next until all are connected. The order does not matter.

A special interface may be obtained to enable Boulderlink to be used with other control systems. Contact your Boulder dealer for details.

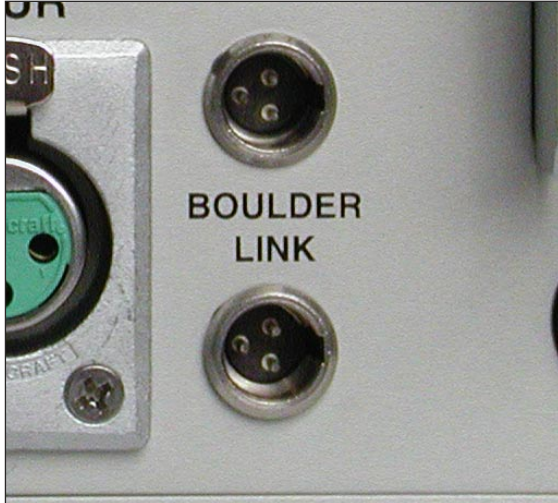



SETTING BOULDERLINK SWITCHES

Every Boulderlink system must have one “MASTER” component, and only one component can be set to MASTER. Usually this is the preamplifier. Power amplifiers and other products not having a MASTER/SLAVE switch are not eligible to be “MASTER.”

On the 1012, set the Boulderlink toggle switch to MASTER.

SETTING BOULDERLINK ID NUMBERS

Each component is required to have a unique Boulderlink ID number. The 1012 ID is preset to 20 at the factory and/or when a master reset sequence is executed. If multiple preamplifiers are connected together, see pages 4-5 through 4-6 for instructions on how to change the ID numbers of the additional units.

Each Boulder 1000 and 2000 power amplifier has a thumbwheel switch on the rear panel. Start by setting the first switch to 0 or 1 and then going up from there without any duplication. Use of the lowest numbers will speed up turn on as each amplifier is allowed about 3 seconds before the next. This spreads out the power line inrush currents thus preventing house circuit breakers from unnecessary tripping. Up to 16 power amplifiers may be connected together in one Boulderlink cable daisy chain.





SCANNING...



THIS UNIT IS MASTER
UNIT 1 IS ONLINE



Boulder 1012 DAC/PRE
WAITING FOR AMPS 0



THIS UNIT SLAVE #20
SCANNING...



THIS UNIT SLAVE #20
THERE IS NO MASTER!

POWER UP VIA BOULDERLINK

With each component connected together with a Boulderlink cable, and individually connected to the mains, pressing the 1012's POWER pushbutton will initiate the turn on sequence of all components.

The first time a "MASTER" 1012 is powered up, it will search for any "slave" units connected to it. As the Master finds each slave, the slave's ID number will be shown on the display.

If any of the connected slaves are amplifiers, then each time the master is turned on it will display "WAITING FOR AMPS." Each amplifier will be turned on in the order of their Boulderlink ID. To minimize turn on time, the amplifier's Boulderlink IDs should be set to the lowest sequential numbers possible. For example, use 0, 1, and 2 instead of 13, 14, and 15. An amplifier set to ID 15 will take 47 seconds to turn on.

A 1012 set to "SLAVE," will display "THIS UNIT SLAVE #20."

If there is no component set to "MASTER," the 1012 will display "THERE IS NO MASTER!" In this case, the 1012's MASTER/SLAVE switch should be set to MASTER. It may take up to 30 seconds for the 1012 to recognize the switch change.



D1. DIGITAL INPUT 1
AMPLIFIER 1 ERROR



D1. DIGITAL INPUT 1
AMPLIFIER 1 HAS DC



D1. DIGITAL INPUT 1
AMPLIFIER 1 IS HOT



D1. DIGITAL INPUT 1
AMPLIFIER CLIP

BOULDERLINK MESSAGES

Each component in the system can send a message to the 1012 which is then shown on its display. This is particularly helpful in confirming the operating status of each power amplifier in a multiple amplifier system.

“AMPLIFIER 1 ERROR” means that an internal power supply has failed and the amplifier has turned itself off to protect the speakers from damage.

“AMPLIFIER 1 HAS DC” means that it has turned itself off due to a DC offset voltage being detected at its inputs.

“AMPLIFIER 1 IS HOT” means that it has turned itself off due to a higher than normal temperature condition on the heatsinks.

“AMPLIFIER CLIP” means that the amplifier’s output has momentarily reached its voltage limitation.



D1. DIGITAL INPUT 1
UNIT 1 IS OFFLINE

“UNIT 1 IS OFFLINE” means that the slave is no longer responding via Boulderlink. Its Boulderlink cable may have become disconnected, or the mains power has been disconnected.



D1. DIGITAL INPUT 1
UNIT 1 IS ONLINE

“UNIT 1 IS ONLINE” means that the slave is now responding via Boulderlink in a normal manner and has been recognized by the master.



RECORDING

A separated analog output is provided for making recordings or supplying a fixed level output to other system components.

CONNECTING A RECORDING DEVICE

A recording device may be connected to the 1012 DAC Preamplifier. You may use balanced or unbalanced connections as previously described in the sections on connecting power amplifiers. See pages 1-8 and 1-9.

1012 AUDIO BLOCK DIAGRAM

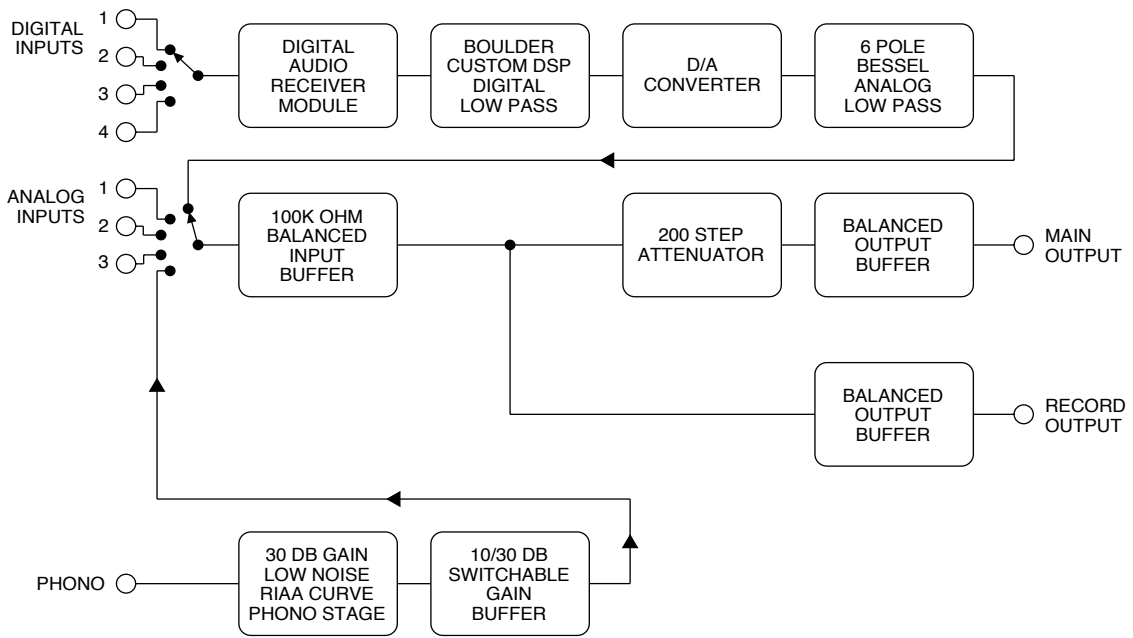

7-1

APPENDIX

BOULDER 1012 DAC PREAMPLIFIER SPECIFICATIONS

DIGITAL INPUTS

Digital Inputs	3 AES/EBU, Adapts to SPDIF (1 DABL Adapter included), 1 Toslink
Sampling Rates	32, 44.1, 48, 88.2, 96 kHz, (AES/EBU)
Maximum DSP Sample Rate for Future I/F	192 kHz
Digital Signal Processor Speed	1 GFLOPS, 167 MHz Clock
Decoding System	64 Bit Math, 24 Bit Output
Upandoversampling™	32, 44.1, 48, kHz: 16X, 88.2, 96 kHz: 8X
Converters per Channel	2
Analog Anti-imaging Filter	3 Stage, 6 Pole Bessel
Full Scale Output Level at Record Output	4.25 Vrms
THD+N, 0 dBFS, 20 Hz to 1 kHz	0.0015% (-96.5 dB)
THD+N, 0 dBFS, 20 kHz	0.0075% (-82.5 dB)
S/N Ratio, A wtd.	109 dB
S/N Ratio, Unweighted	107 dB
Frequency Response, 0.03 Hz to 20 kHz	+0.00, -0.5 dB

ANALOG INPUTS

Balance Line Inputs	3
Phono Inputs, Balanced Connector	1
Main Balanced Outputs	1
Record Balanced Outputs	1

7-2

APPENDIX

BOULDER 1012 DAC PREAMPLIFIER SPECIFICATIONS (CTD)

Maximum Input Level	6.0 Vrms
Maximum Output Level	14.0 Vrms
THD+N, 2V Output, from 20 Hz to 20 kHz	0.0015% (-96.5 dB)
Output loaded with 150Ω	Less than 1 dB distortion change, 20 - 10 kHz
Maximum Voltage Gain, Line input	20 dB
Maximum Voltage Gain, Phono (MM)	60 dB
Maximum Voltage Gain, Phono (MC)	80 dB
Volume Range	100 dB
Volume Steps	0.5 dB \pm 0.05 dB
Record Path Gain, Balanced Output	8.5 dB
Record Path Gain, Unbalanced Output	2.5 dB
Frequency Response, 20 Hz to 20 kHz	+0.00, -0.03 dB
Frequency Response, -3 dB at	0.02 Hz & 250 kHz
Clip to noise ratio	118 dB
Crosstalk, L to R or R to L	-101 dB or better 20 Hz to 20kHz
Crosstalk, Adjacent Inputs	-115 dB or better 20 Hz to 20kHz
Input Impedance	100kΩ Balanced
Output Impedance	100Ω Balanced, 50Ω Unbalanced
Preamp Size, W x H x D	18.0 x 5.750 x 15.75 inches
Power Requirements	100 / 120 / 220-240 V, 50-60 Hz, 75 W Max.

7-3

APPENDIX

TROUBLESHOOTING		
SYMPTOM	CAUSE	REMEDY
No power indication	Preamplifier is not plugged in	Connect to an AC outlet
Analog source selected, Amber power indication but sound not heard from either channel	No signal from source	Check source controls, cables and connections
	No signal to power amplifier	Check amplifier power status, cables and connections
	Preamp is defective	Return to dealer for service
Amber power indication, but sound not heard from one channel	No signal from one channel of source	Check source controls, cables and connections
	One Channel is muted by balance control	Push BALANCE and recenter
Digital source is selected, but no input signal is displayed	D/A Converter is not receiving digital signal from source	Check controls, cables and connections from the digital source
Displays "UNIT x ONLINE," then "UNIT x OFFLINE" continuously	More than one slave unit has the same Boulderlink ID	Make certain all slave units have a unique Boulderlink ID. See page 5-2

NOTES

7-5

APPENDIX